

## Instructions for Using the Onsite Tiered Permitting - Flowchart

(For non-RCRA or exempt hazardous waste facilities conducting onsite treatment. For example, generators treating waste onsite within 90/180 days are not required to get a permit pursuant to federal regulations.)

### Using the TP Flowchart

1 <sup>st</sup> column	2 <sup>nd</sup> column	3 <sup>rd</sup> column	4 <sup>th</sup> column
Waste Type	Treatment	Volume Treated	Concentration
What is the waste stream?	How is the waste being treated? What is the process used?	Tiers are often dependent upon volume treated.	Tiers often dependent upon concentration.

# Going with the Flow (chart)

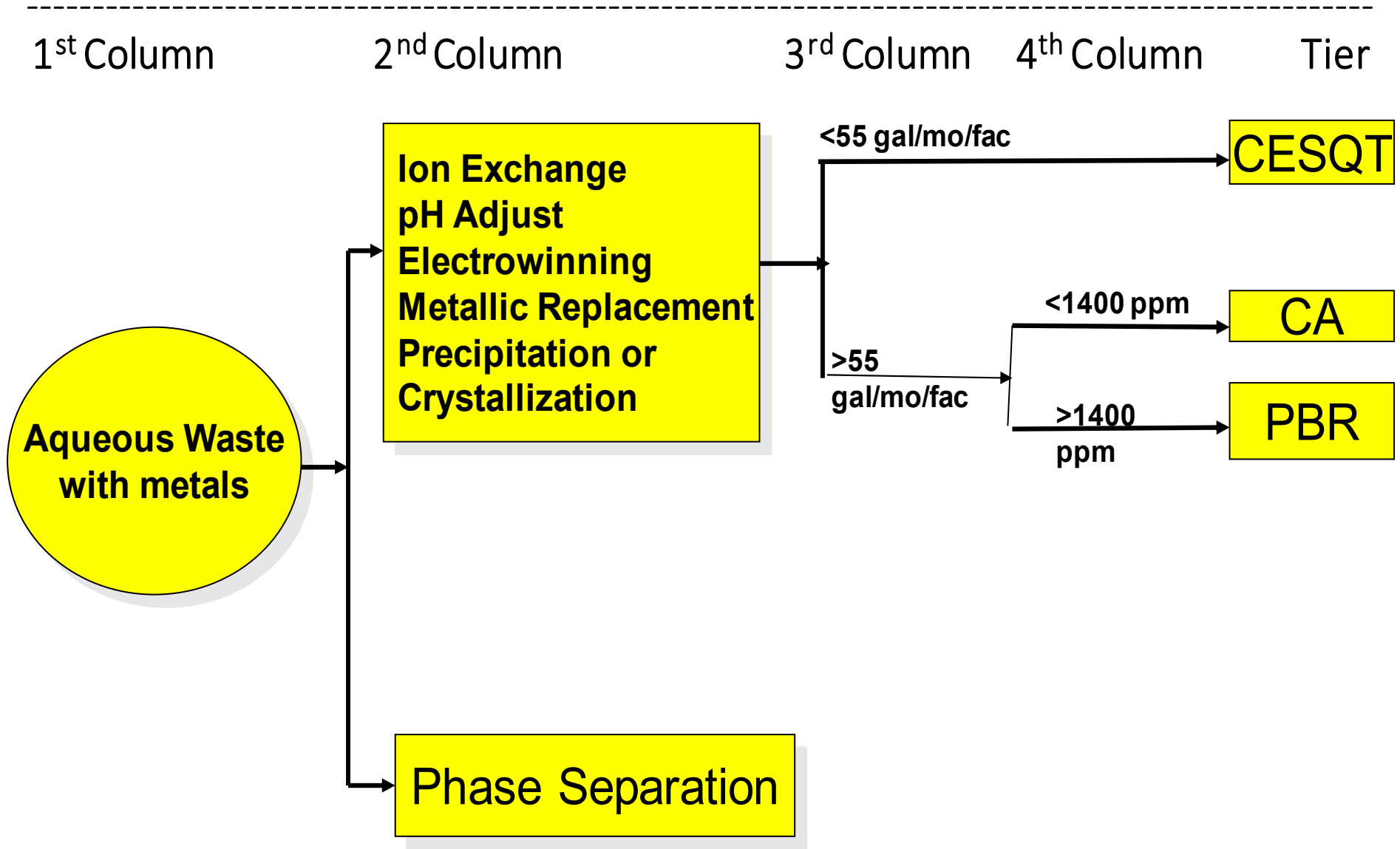

**Onsite Tiered Permitting – Flowchart**  
**Waste Stream #s 1 through 20 are in §67450.11 unless listed**

(For non-RCRA or exempt hazardous waste facilities conducting onsite treatment.)

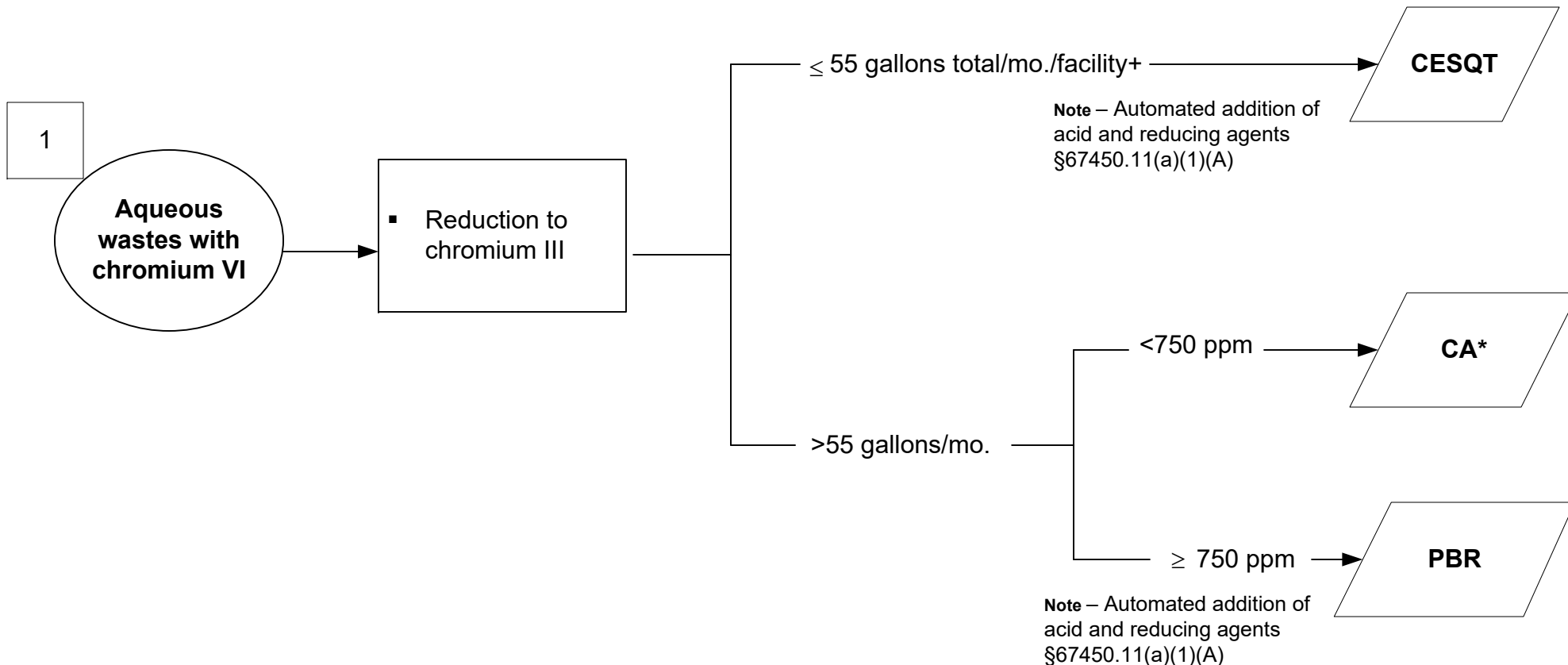

**CESQT - Conditionally Exempt Small Quantity Treatment (Health and Safety Code (HSC § 25201.5(a))**

**A CESQT facility can only treat a total volume of not more than 55 gallons/month at that facility and NO other grant of authorization or permit is required at that facility (HSC § 25201.5(a)(2))**

**CESW - Conditionally Exempt Specified Wastestream (HSC § 25201.5(c))**

**CEL - Conditionally Exempt-Limited (HSC § 25201.14)**

**CECL - Conditionally Exempt Commercial Laundries (HSC § 25144.6(c))**

**CA - Conditional Authorization (HSC § 25200.3)**

**PBR - Permit by Rule (Title 22, CCR, Div. 4.5, Chapter 45, § 67450.11)**

**\*Must be hazardous solely (single hazard) due to this characteristic, e.g. corrosivity. Dual or multiple hazards are in PBR**

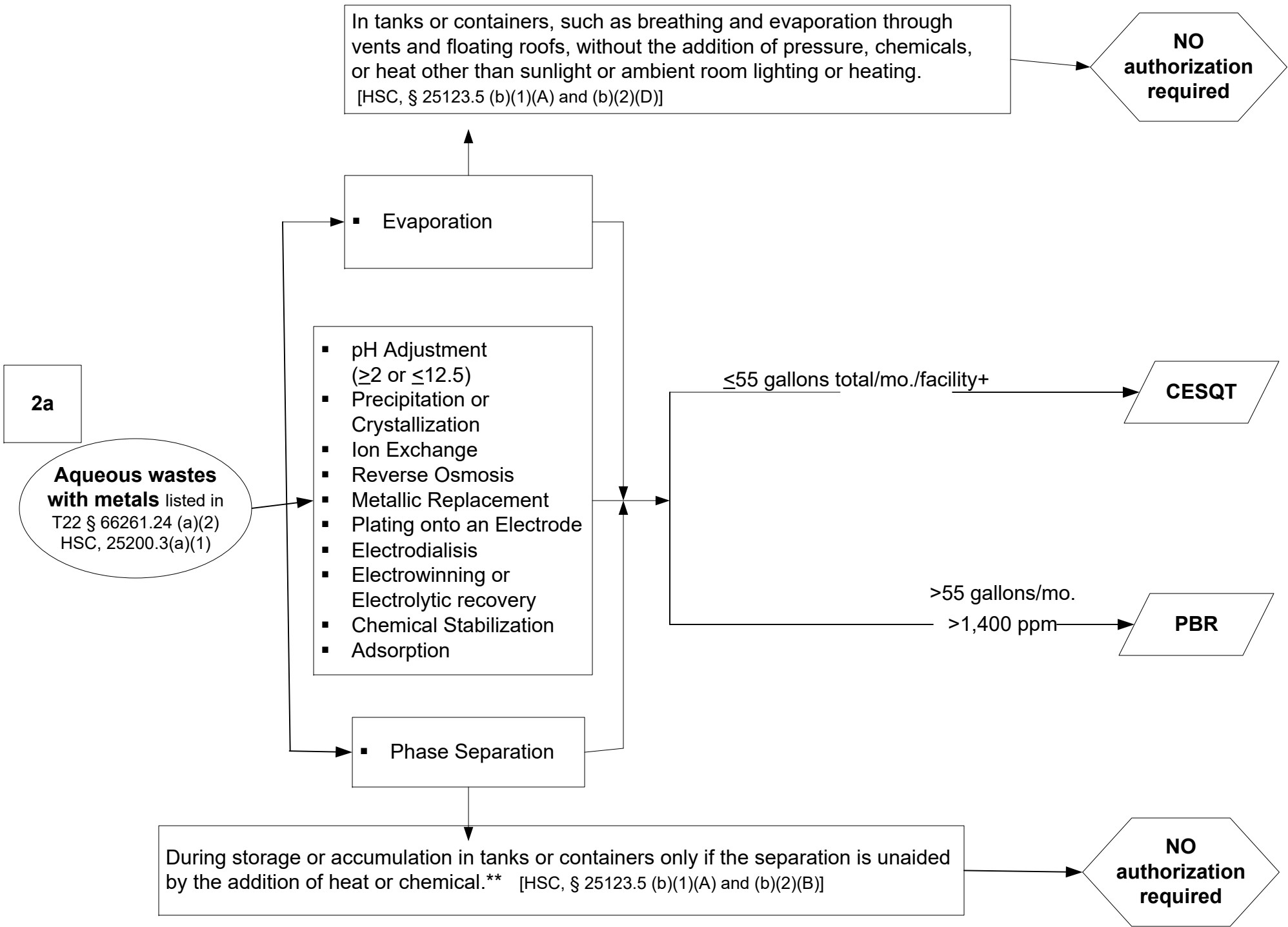

\*\*Containers must be closed except when adding/removing hazardous wastes (T22, § 66265.173)

2b

**Aqueous wastes with metals** listed in T22 § 66261.24

- Ion Exchange
- Reverse Osmosis
- Adsorption
- pH Adjustment ( $\geq 2, \leq 12.5$ )
- Electrowinning or electrolytic recovery (no hydrochloric acid)

- Phase Separation

>55 gallons/mo.  
&  
<1,400 ppm

CA\*

During storage or accumulation in tanks or containers only if the separation is unaided by the addition of heat or chemical.\*\*  
[HSC, § 25123.5 (b)(1)(A) and (b)(2)(B)]

**NO authorization required**

\*Must be hazardous solely (single hazard) this due to characteristic, e.g. corrosivity.

\*\*Containers must be closed except when adding/removing hazardous wastes (T22, § 66265.173)

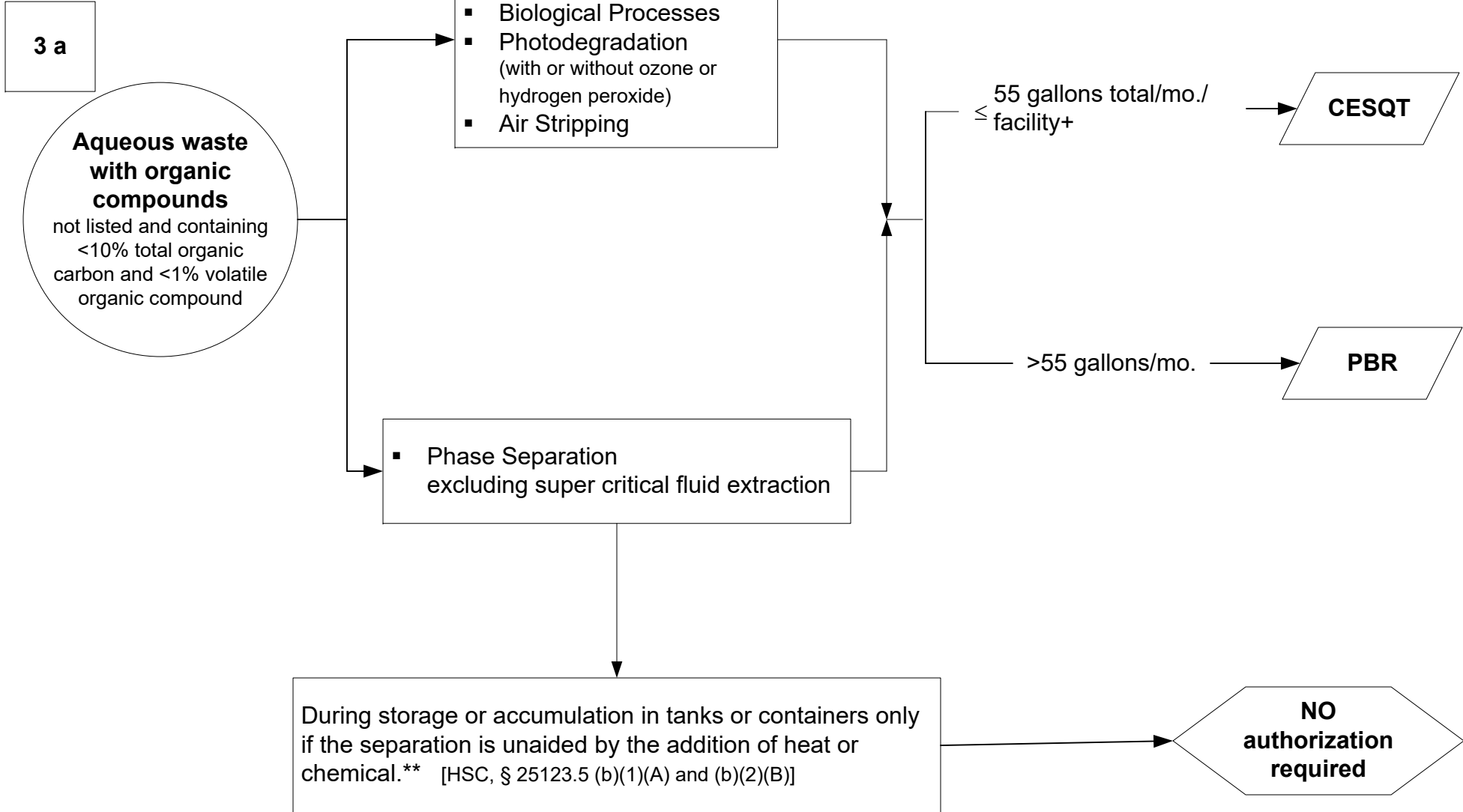

\*\*Containers must be closed except when adding/removing hazardous wastes (T22, § 66265.173)

3 b

**Aqueous waste with organic compounds**  
listed in  
§ 66261.24(a)(1)(B) or  
§ 66261.24(a)(2)(B)

▪ Adsorption

▪ Phase Separation  
excluding super critical fluid extraction

During storage or accumulation in tanks or containers only if the separation is unaided by the addition of heat or chemical.\*\*  
[HSC, § 25123.5 (b)(1)(A) and (b)(2)(B)]

<750 ppm → CA\*

**NO authorization required**

\*Must be hazardous solely (single hazard) due to this characteristic, e.g. corrosivity.

\*\*Containers must be closed except when adding/removing hazardous wastes (T22, § 66265.173)

In tanks or containers, such as breathing and evaporation through vents and floating roofs, without the addition of pressure, chemicals, or heat other than sunlight or ambient room lighting or heating.

[HSC, § 25123.5 (b)(1)(A) and (b)(2)(D)]

**NO  
authorization  
required**

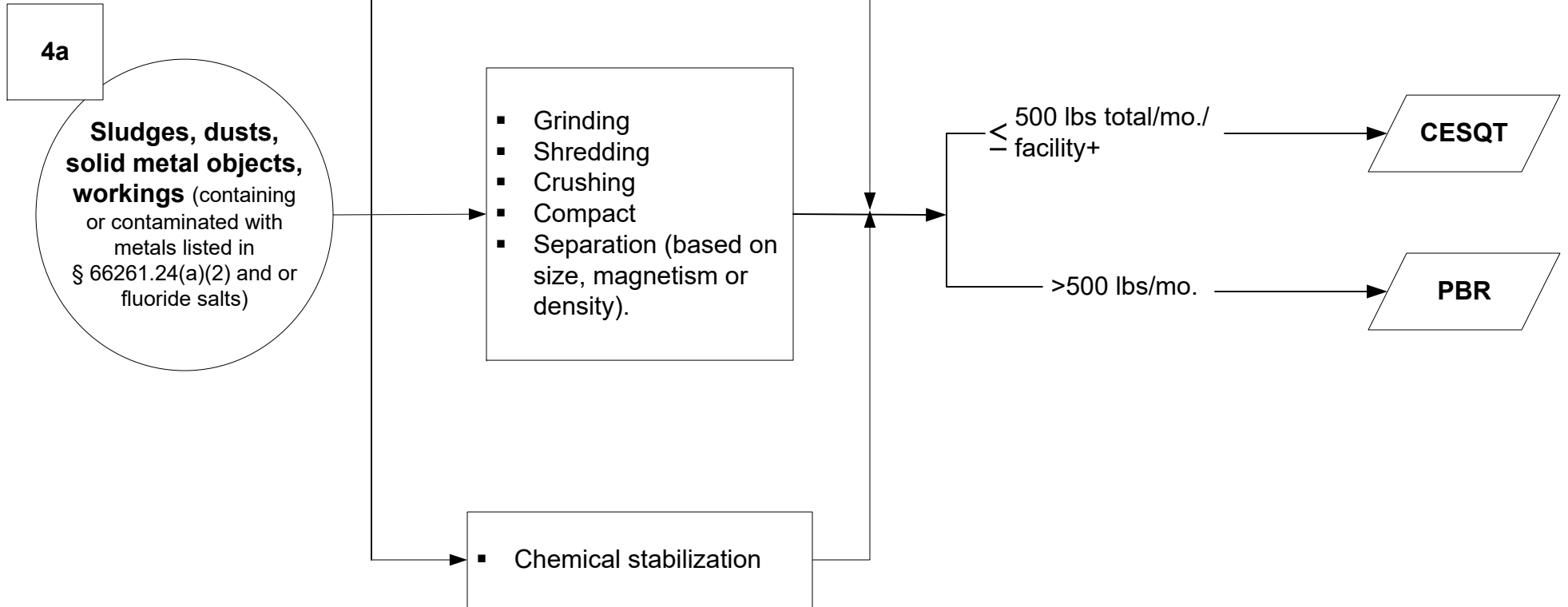



In tanks or containers, such as breathing and evaporation through vents and floating roofs, without the addition of pressure, chemicals, or heat other than sunlight or ambient room lighting or heating.  
[HSC, § 25123.5 (b)(1)(A) and (b)(2)(D)]

**NO  
authorization  
required**

4b

**Wastewater treatment sludges, solid metal objects, metal workings**  
containing or contaminated with metals and Dusts containing  $\leq 750$  ppm metal (except asbestos) (§ 66261.24(a)(1)(B) or § 66261.24(a)(2)(A))

▪ Drying (to remove water)

- Centrifuge
- Gravity Settling
- Grinding
- Shredding
- Crushing
- Compact
- Separation (based on size, magnetism or density).

▪ Filtration

$\leq 45,000$  lbs/mo.

**CA\***

**Sieving or filtering liquid hazardous waste** to remove solid fractions, without added heat, chemicals, or pressure, as the waste is added to or removed from a storage or accumulation tank or container. For this activity, sieving or filtering does not include adsorption, reverse osmosis, or ultrafiltration.  
[HSC, § 25123.5 (b)(1)(A) and (b)(2)(B)]

**NO  
authorization  
required**

\*Must be hazardous solely (single hazard) due to this characteristic, e.g. corrosivity.

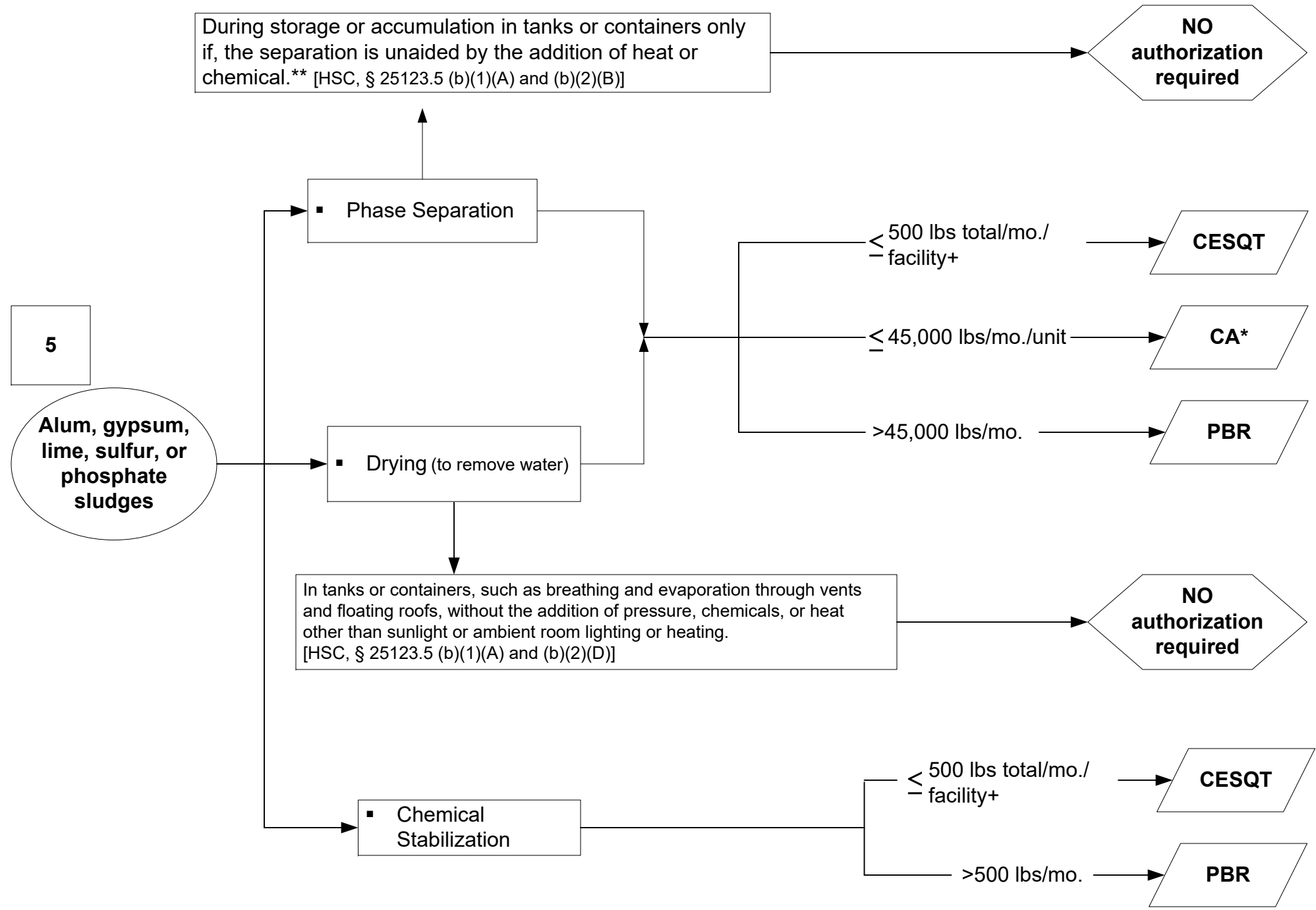

\*Must be hazardous solely (single hazard) due to this characteristic, e.g. corrosivity.

\*\*Containers must be closed except when adding/removing hazardous wastes (T22, § 66265.173)

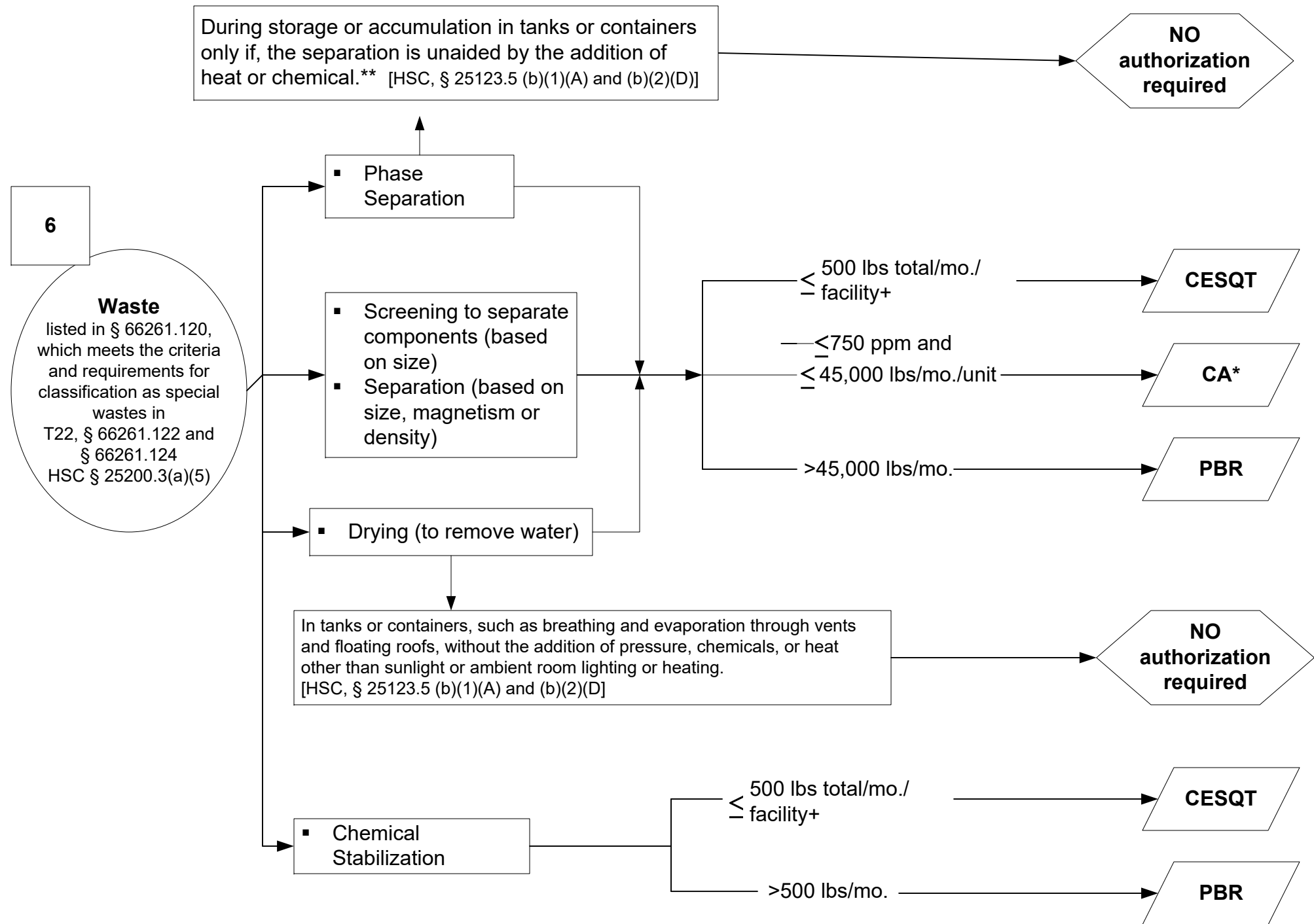

\*Must be hazardous solely (single hazard) due to this characteristic, e.g. corrosivity.

\*\*Containers must be closed except when adding/removing hazardous wastes (T22, § 66265.173)

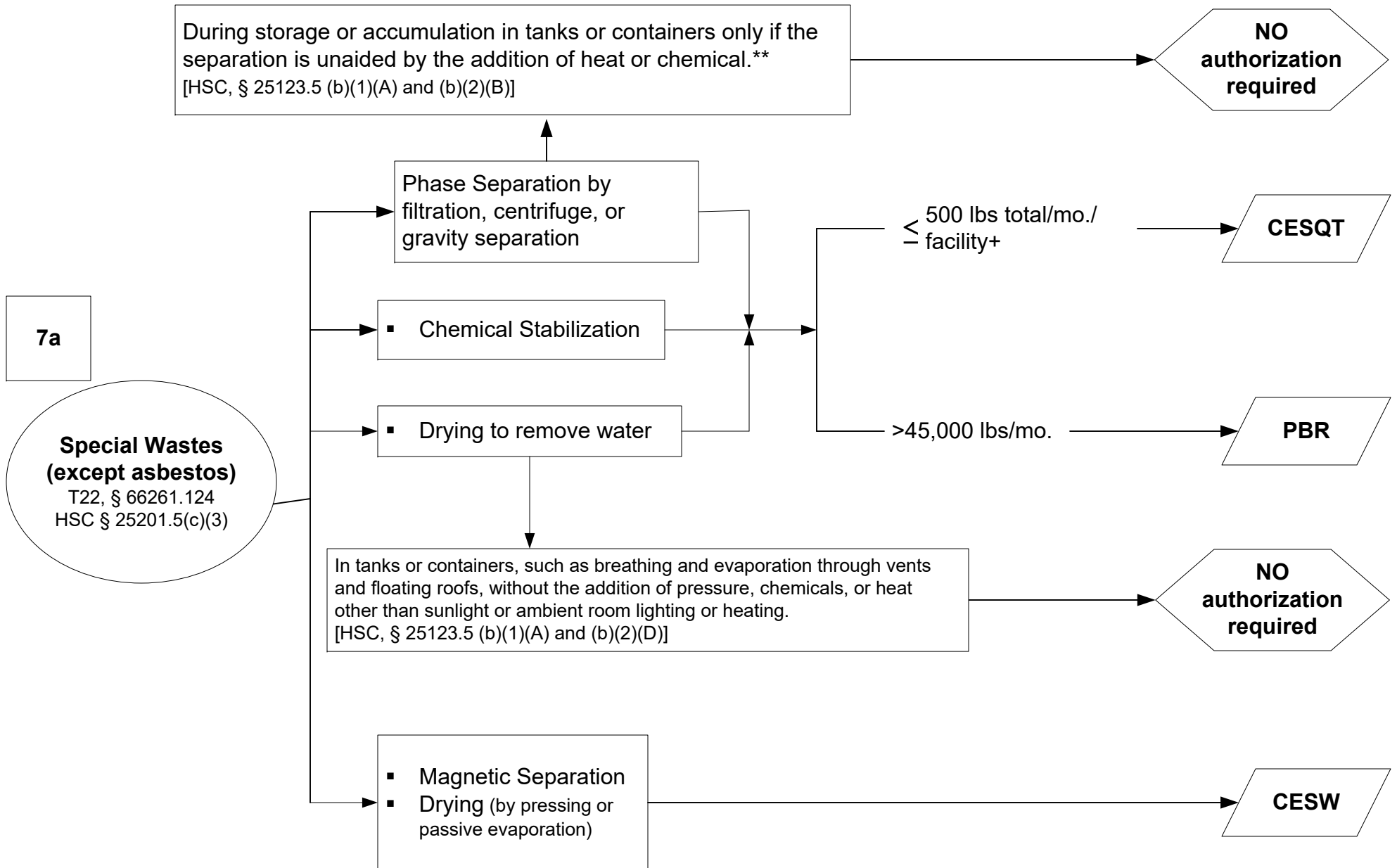

\*\*Containers must be closed except when adding/removing hazardous wastes (T22, § 66265.173)

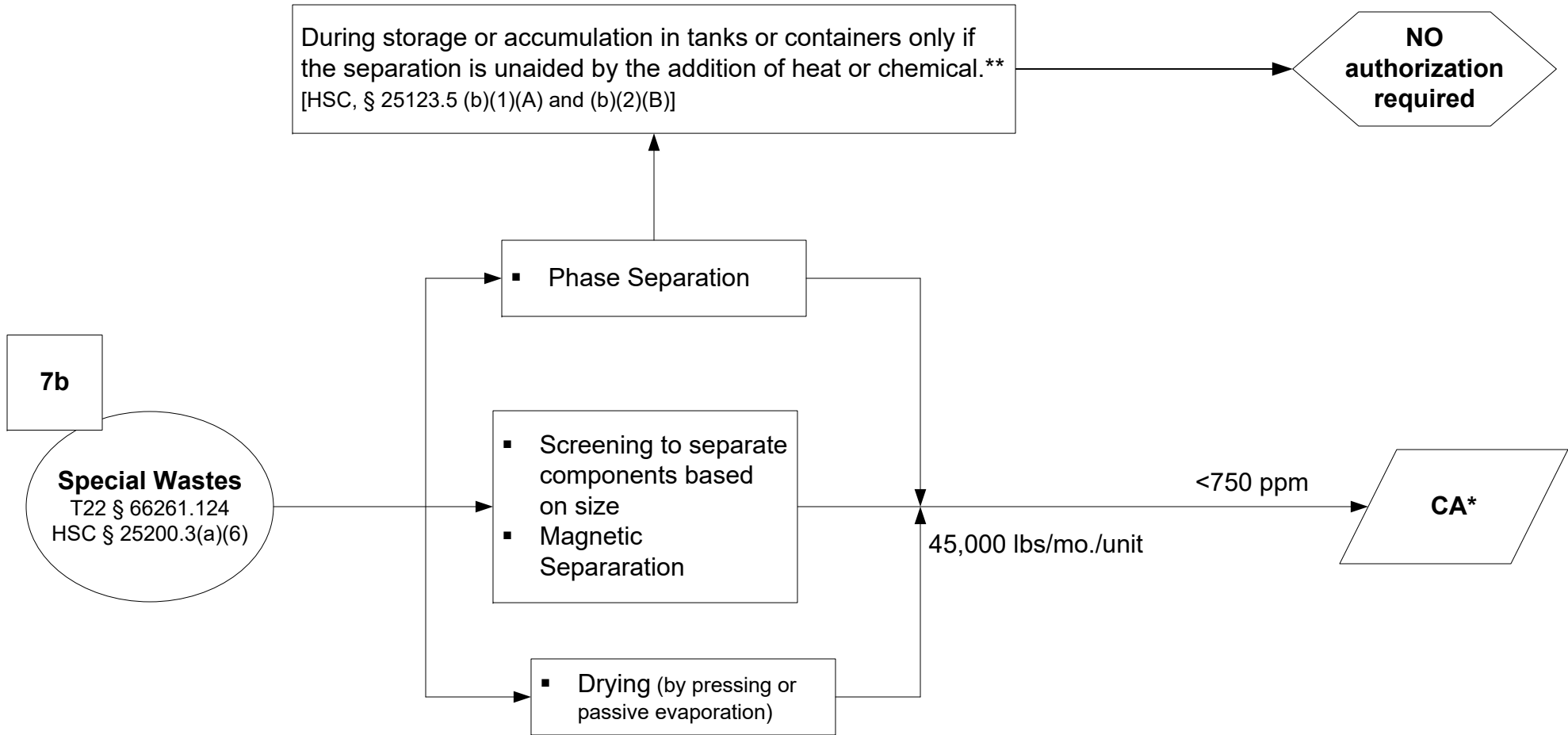

\*Must be hazardous solely due to this characteristic

\*\*Containers must be closed except when adding/removing hazardous wastes (T22, § 66265.173)

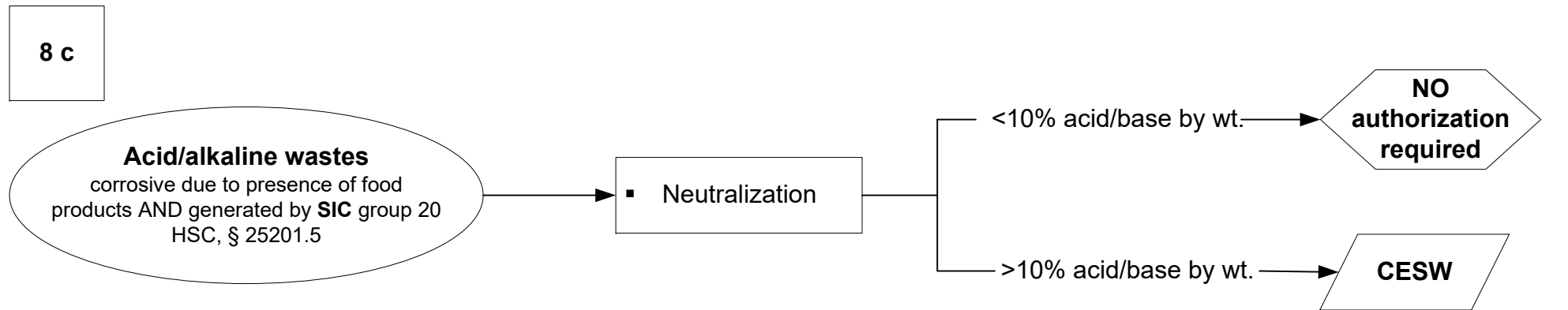
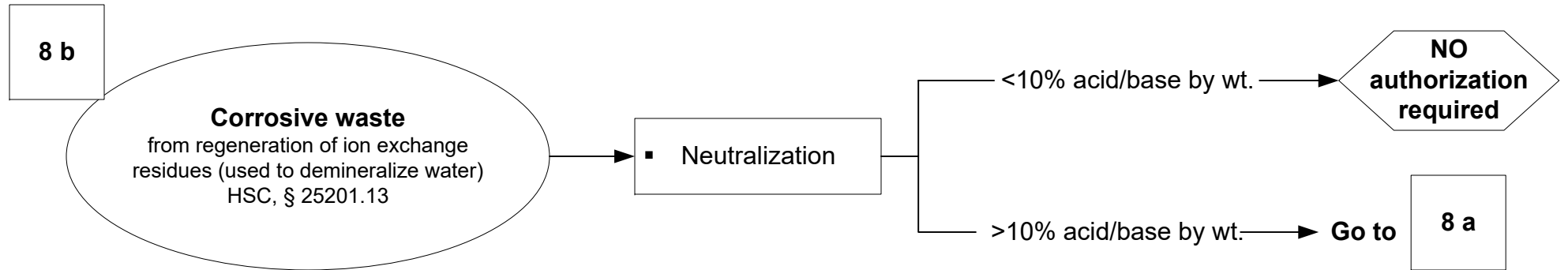
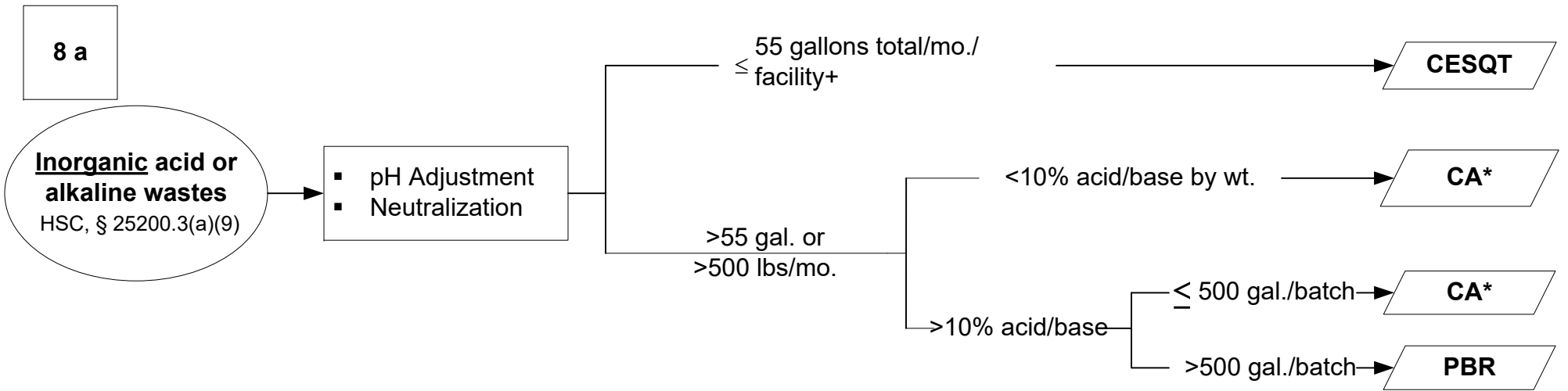

\*Must be hazardous solely (single hazard) due to this characteristic, e.g. corrosivity.

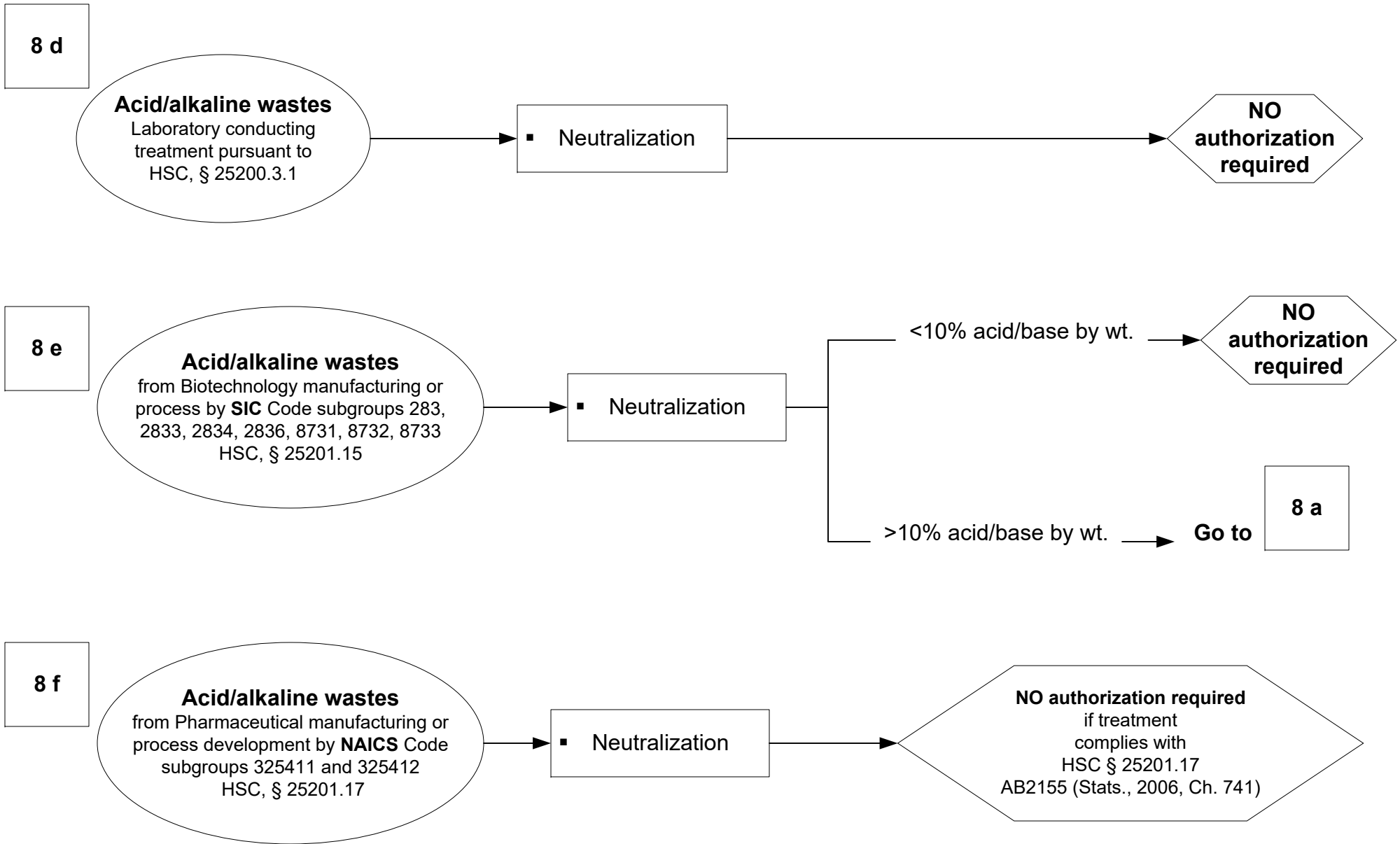

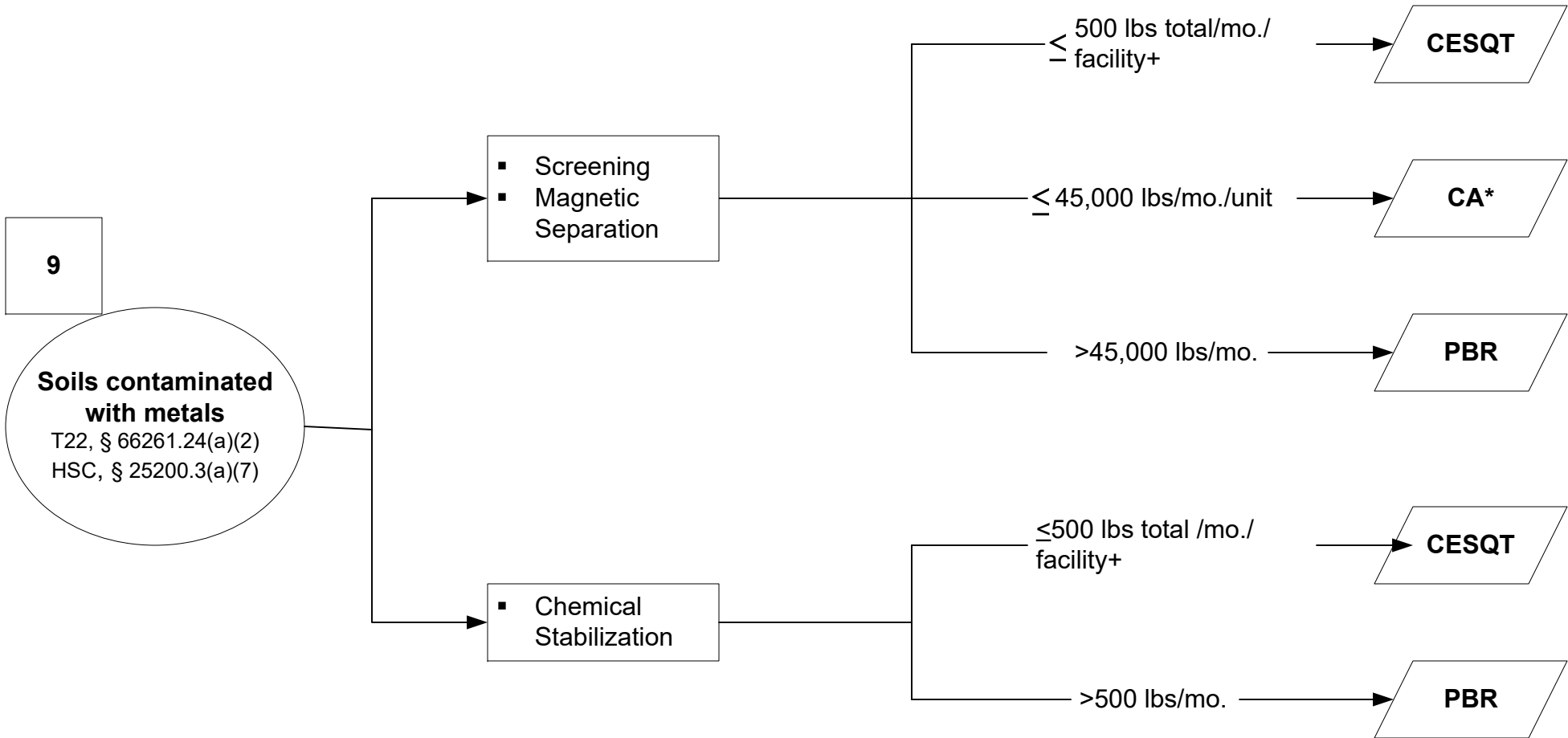

\*Must be hazardous solely (single hazard) due to this characteristic, e.g. corrosivity.



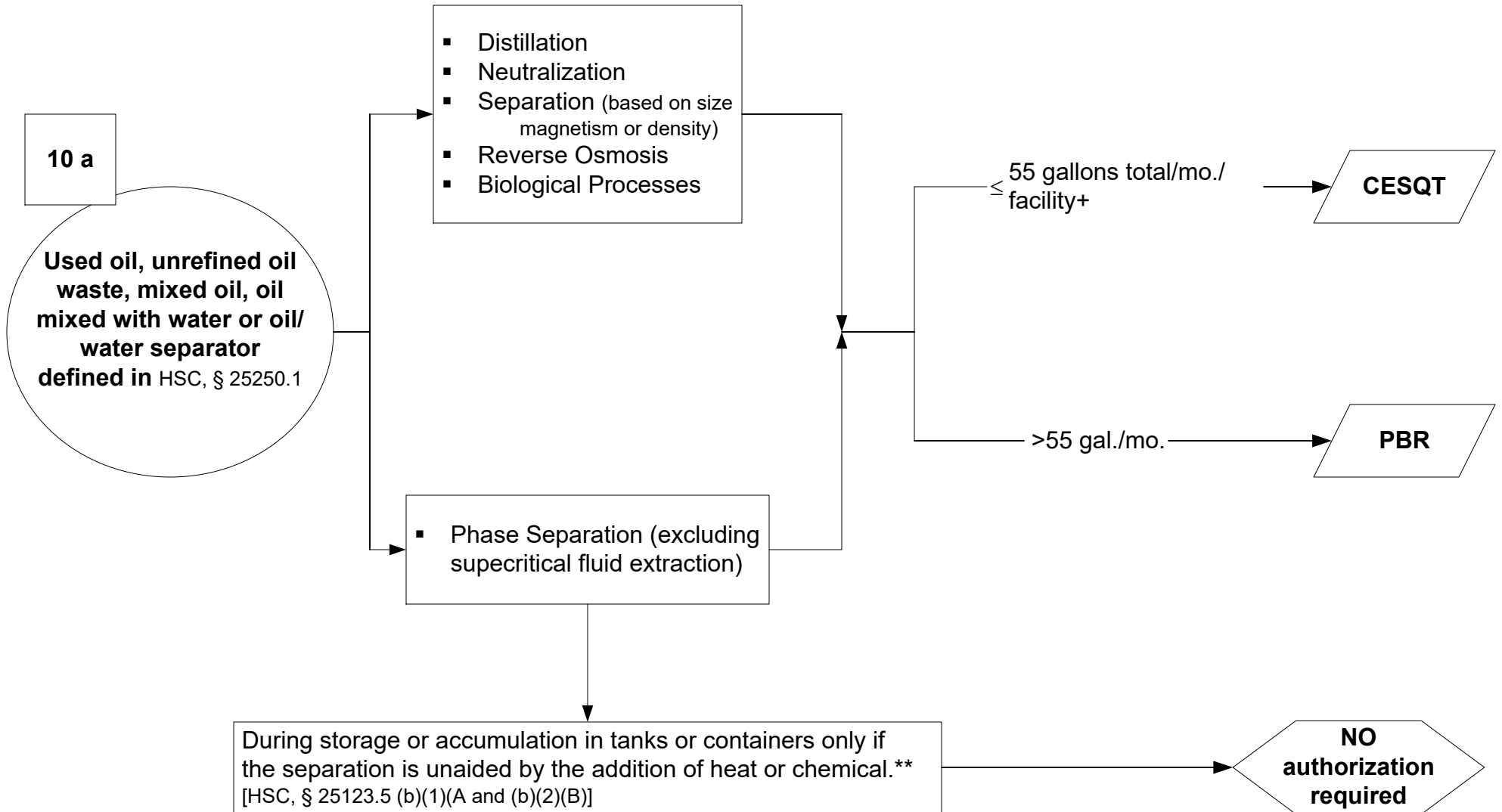

\*\*Containers must be closed except when adding/removing hazardous wastes (T22, § 66265.173)

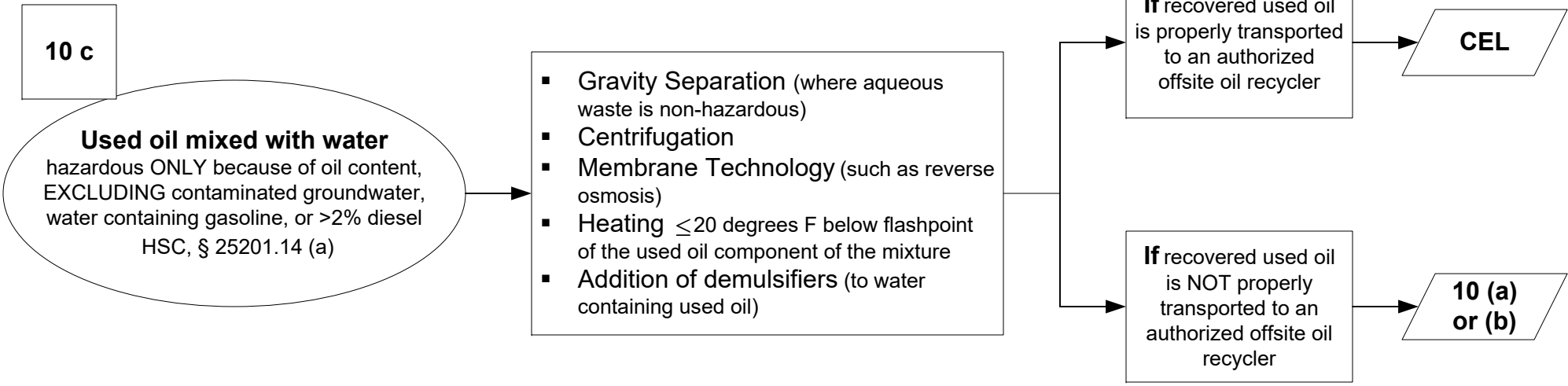
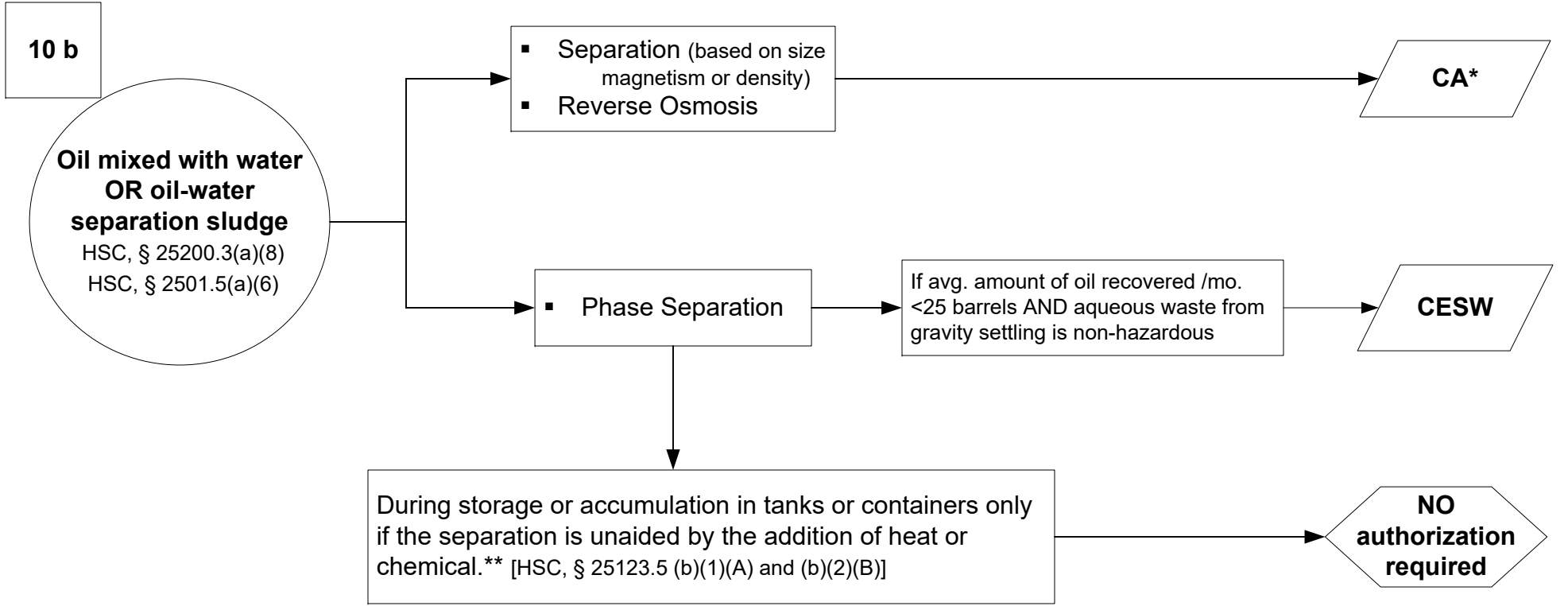

\*Must be hazardous solely (single hazard) due to this characteristic, e.g. corrosivity.  
 \*\*Containers must be closed except when adding/removing hazardous wastes (T22, § 66265.173)

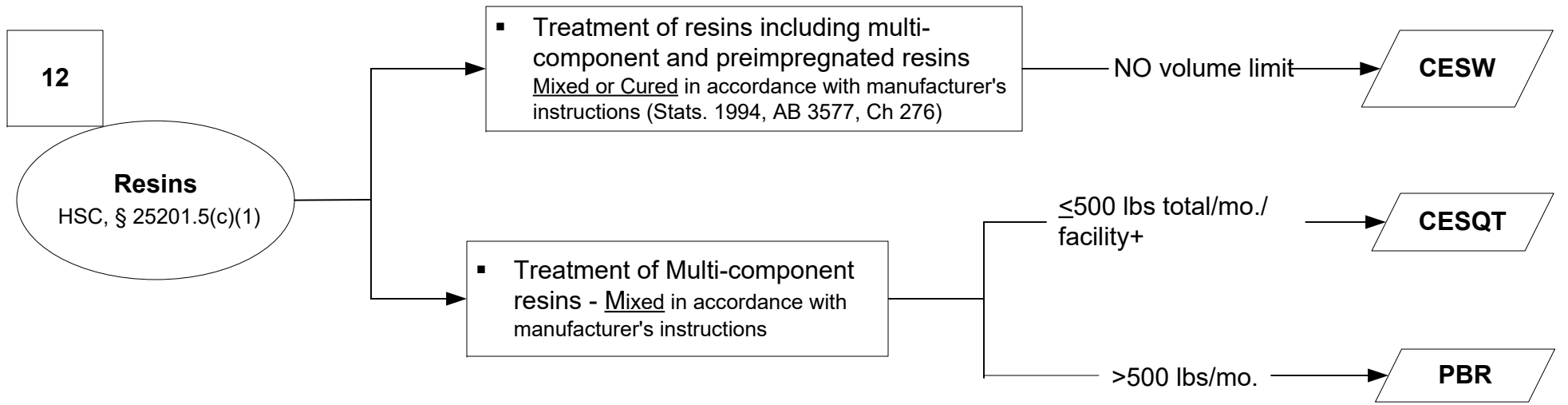
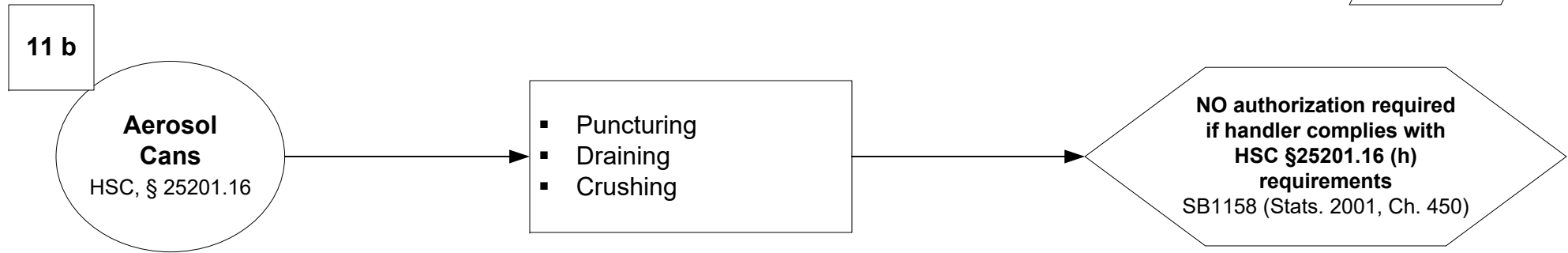
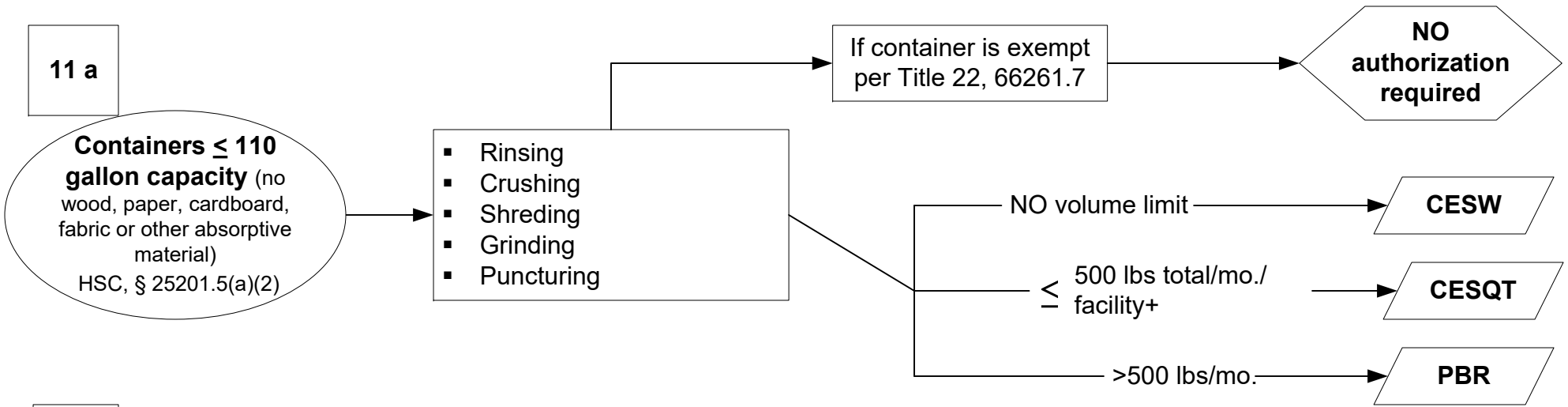

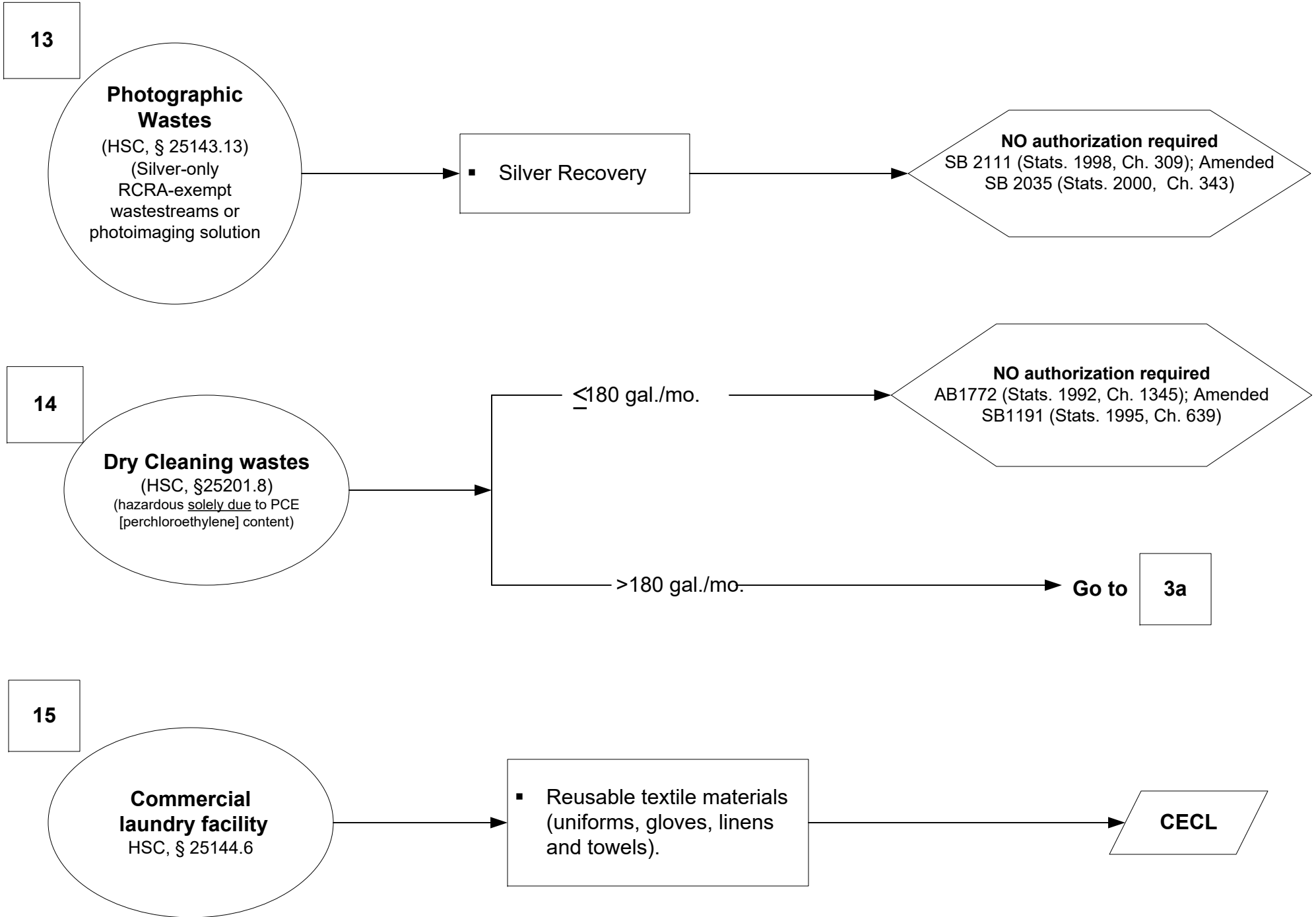

16a

**Laboratory Waste**  
HSC § 25200.3.1

CESW

**NO authorization required**  
if treatment complies with  
HSC, § 25200.3.1  
AB 966 (Stats. 1998, Ch. 506)

16b

**Quality Control or  
Quality Assurance  
Laboratory**  
(HSC, § 25201.5(c)(8))

CESW

**NO authorization required**  
if treatment complies with  
HSC § 25200.3.1  
AB 966 (Stats. 1998, Ch. 506)

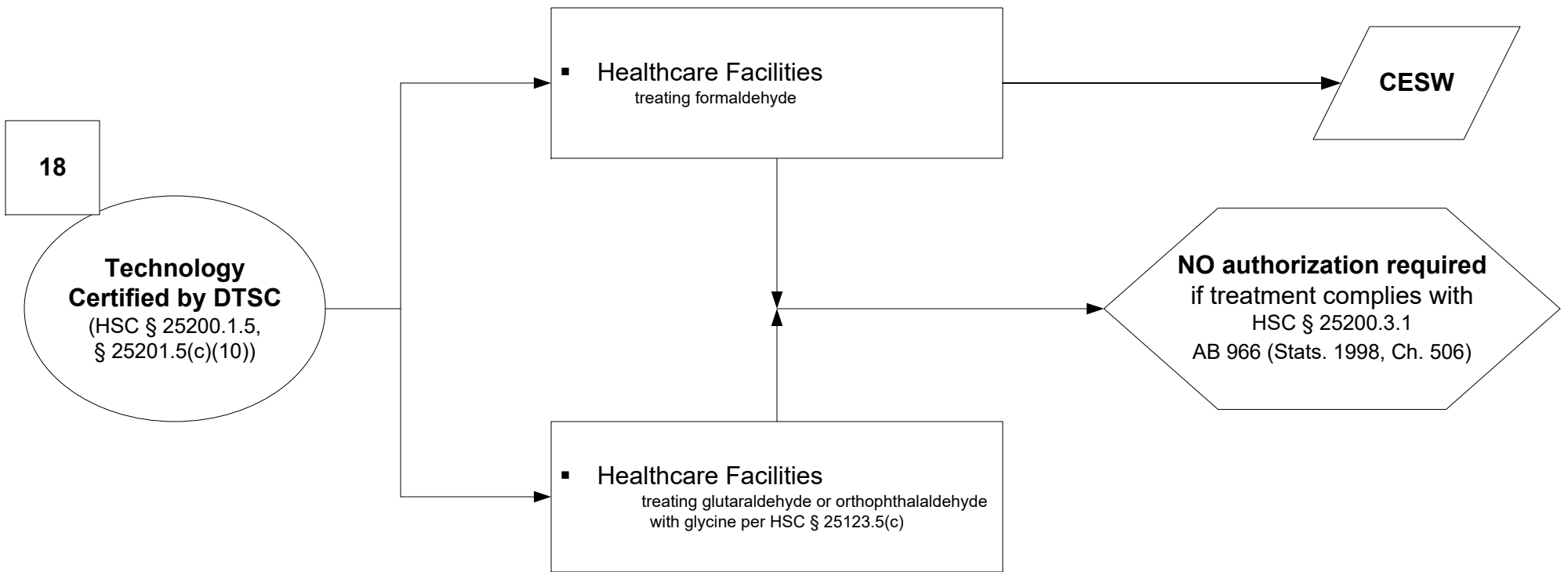

\*Must be hazardous solely (single hazard) due to this characteristic, e.g. corrosivity.

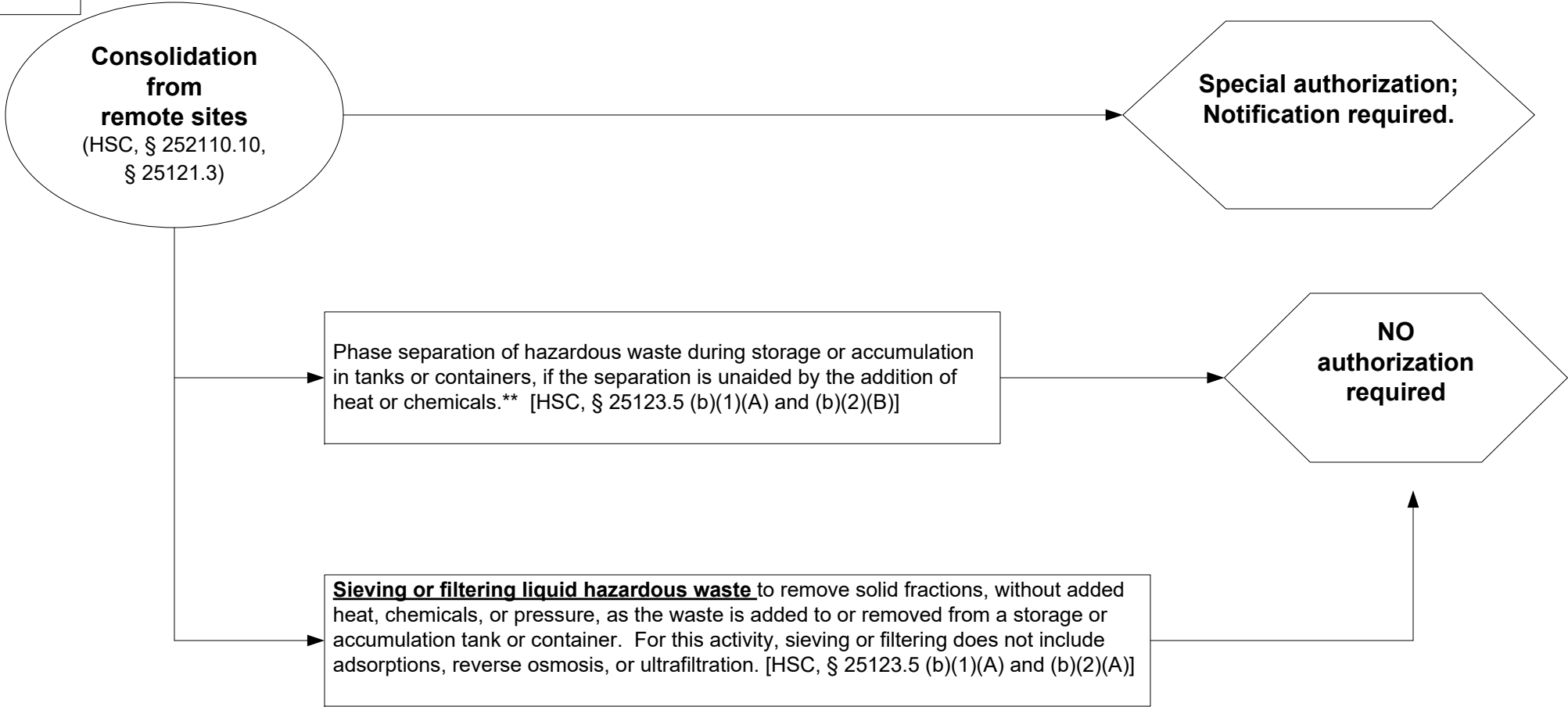

\*\*Containers must be closed except when adding/removing hazardous wastes (T22, § 66265.173)

# Cyanide Treatment (T22 § 67450.11 (d)(2))

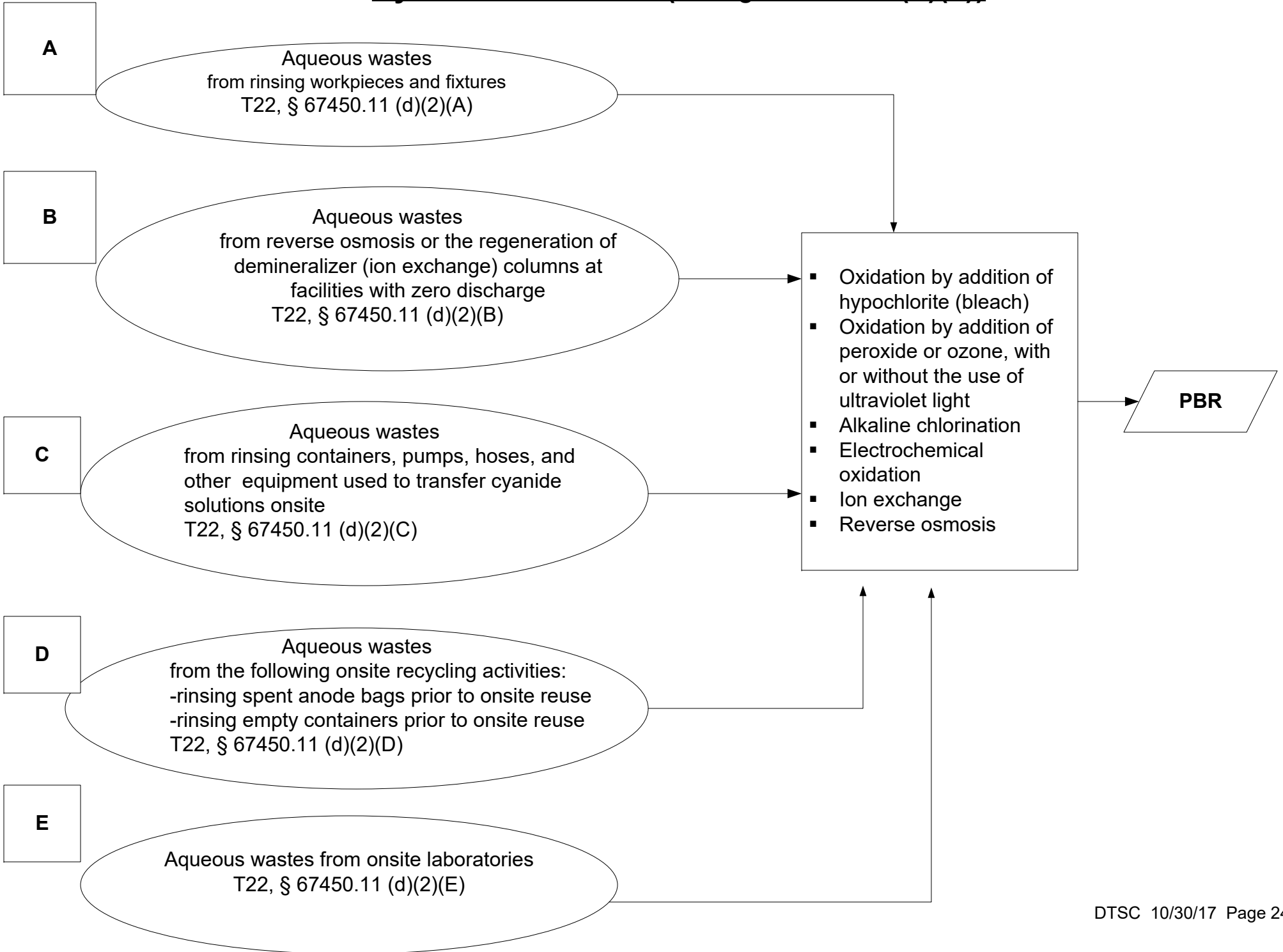



## Cyanide Treatment (T22, § 67450.11 (d)(2))

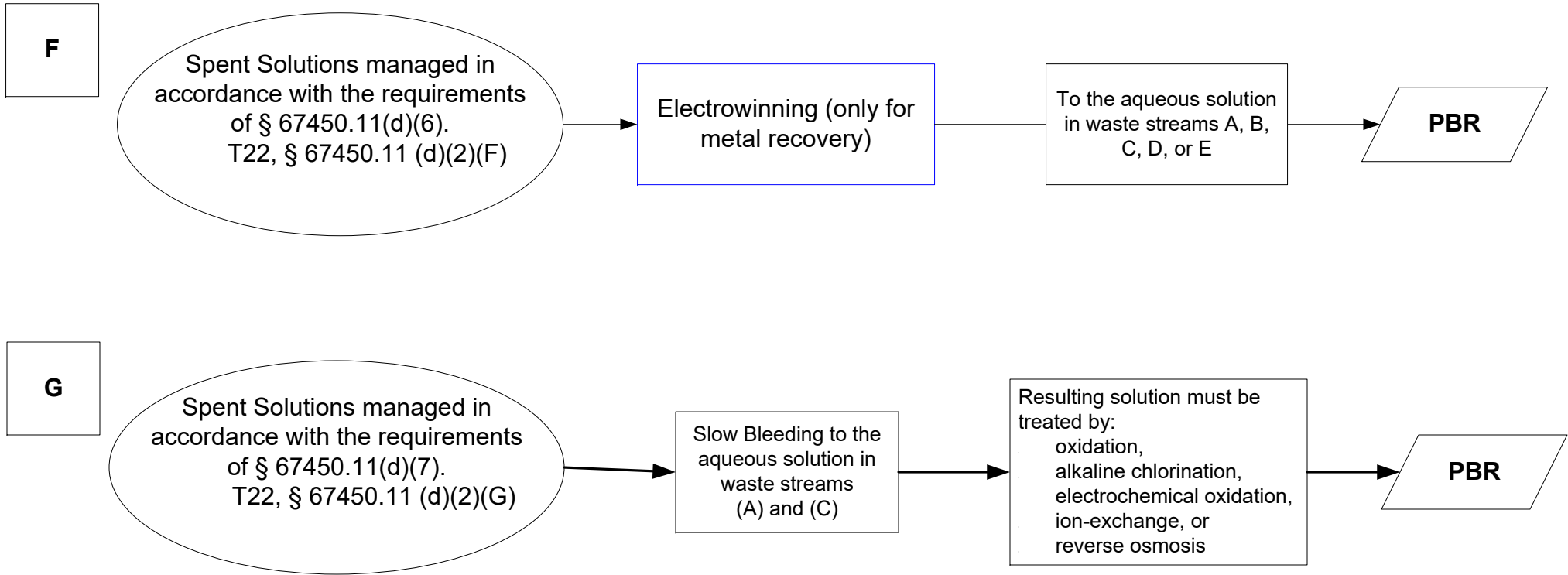

**Additional Requirements for Dilution of Process Solutions:**

- Total cyanide concentration limited to 5,000 mg/l after dilution
- Written approval from the agency operating the POTW
- Waste analysis plan (cyanides)
- The residual solids removed are recycled by a facility that recovers metals including documentation
- By January 30 - Prepare justification statement when residuals are not recycled for the previous calendar year
- Records maintained at the facility for 3 years

**For all Cyanide Treatments under PBR:**

- Comply with Best Management Requirements
- Employee training (Initial and annual training to employees, who handle cyanide process solutions, cyanide rinse waters, or manage cyanide waste)
- Evaluate cyanide alternatives every 4 years

# Transportable Treatment Units

Note - SUBMIT TTU NOTIFICATIONS TO DTSC, NOT TO THE CUPA.

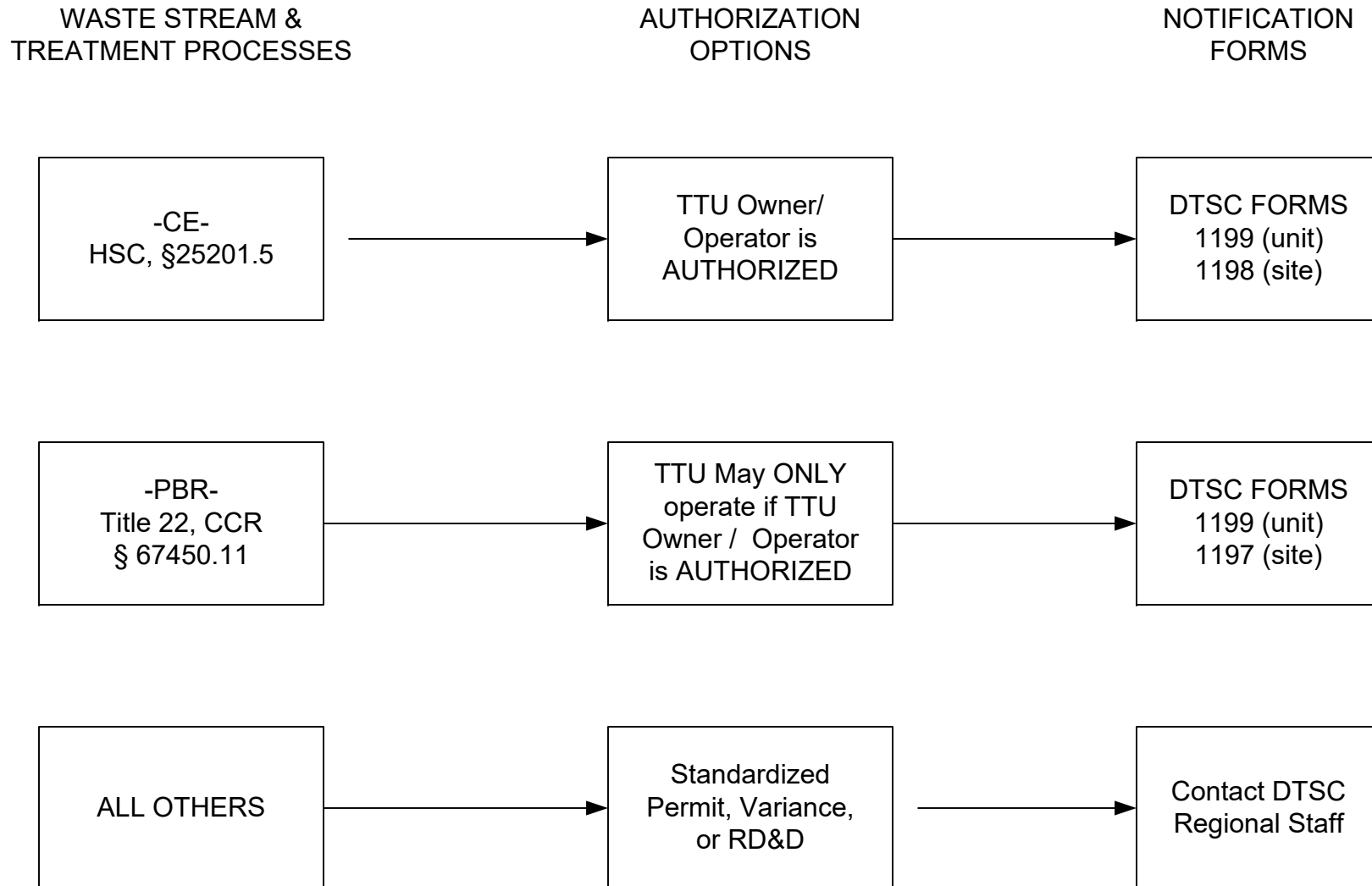

# PBR - Household Hazardous Waste Collection Facilities (HHWCFs)

## HHW PBR facilities are for the collection of household and CESQGs wastes

**Note: HHWCFs are NOT to be confused with generator PBR facilities**

